



Fabricated Fitting Butt Fusion Procedure

1.0 Introduction

This document provides the general recommended practice and procedures for butt fusing Hawkeye Industries' fabricated polyethylene fittings, including the polyethylene portion of transition fittings, to a polyethylene pipe system. It is intended for use with Hawkeye's PE3408 and PE4710 / PE 100 fabricated high-density polyethylene fittings. This draft document will be updated as information is available.

2.0 Reference Documents

This procedure makes reference, directly or implied, from the following documents:

ASTM D 2657

Standard Practice for Heat Fusion Joining of Polyolefin Pipe and Fittings

CSA Z662-07

Oil and Gas Pipeline Systems

ERCB Directive 077 (*Rescinds and Replaces EUB Directive 022*)

Pipeline – Requirements and Reference Tools

PPI TR-33/2006

Generic Butt Fusion Joining Procedure for Field Joining of Polyethylene Pipe

PPI TN-13/2007

General Guidelines for Butt, Saddle, and Socket Fusion of Unlike Polyethylene Pipes and Fittings

PPI Handbook of Polyethylene Pipe, 1st Ed.

Chapter 9: Polyethylene Joining Procedures

3.0 Regulations

Read and follow stipulated fusion regulations specified by the local jurisdictional authority.

3.1 Canadian Regulations

Refer to ERCB Directive 077 and CSA Z662-07, Sections 12.7.7.1 through 12.7.9.2.

3.2 US Regulations

Refer to US DOT Title 49 CFR Part 192.

4.0 Precautions

4.1 Connection Method

Hawkeye Industries' fabricated polyethylene fittings shall only be joined to a polyethylene pipe system by the heat fusion, including butt, socket and electrofusion. Threading, solvent bonding, hot-air or hot-gas welding, or extrusion welding techniques, or any other method not explicitly defined as heat fusion, are not permissible for pressure service. This document covers only joining by butt fusion at this time.

4.2 Personnel Qualification

It is imperative that persons joining polyethylene pipe by heat fusion are trained and qualified in the operation of fusion equipment. Proof of qualification may be required in some jurisdictions.

4.3 Fusing unlike PE Materials

Fittings fabricated from HDPE Material are fusion compatible with like-designated resins, regardless of manufacturer. (i.e. Hawkeye's PE3408 fittings can be fused to any manufacturers PE3408 pipe).

Fusing unlike HDPE resins (i.e. PE3408 to PE4710) can result in satisfactory fusion joints. Refer to PPI Document TN-13 for guidelines on fusing materials with unlike melt flow properties. The standard PE100/PE4710 Material used by Hawkeye Industries has a melt index of 0.6 g/10 min.

For joints where 800 psi Hydrostatic Design Stress (HDS) material (i.e. PE3408, PE3608) is joined to 1000 psi material (i.e. PE4710) the, pressure rating of the joint will be the same as the lower-strength material. For this reason, Hawkeye Industries recommends that PE3408/3608/3708 fabricated fittings not be used on PE4710 or PE100 pipe systems. However, PE4710 / PE100 fittings are still acceptable for use on PE3408/3608/3708 systems.

4.4 Hydrocarbon Permeation

Polyethylene pipe and fittings can be affected by liquid hydrocarbon (LHC) contamination. When present, LHC permeates the polyethylene which makes joining by heat fusion inappropriate. Fusions made with LHC contaminated polyethylene may be weak and unreliable, and shall not be allowed into service. Contamination can stem from either LHC in the pipeline or fitting, or from LHC leeching from contaminated soil around the pipeline or fitting.

LHC contamination is only a factor when performing heat fusions. The presence of LHC does not have a negative impact on the performance of the polyethylene pipeline or fitting once in service.

4.5 Handling

Care must be taken when handling fabricated fittings to avoid damage to the fusion surfaces, or the OD of the fitting. Gouging the OD of the fitting can have a deleterious effect on pressure rating, and damaged fittings should not be placed into service. Do not drop fittings from any height.

Steps should be taken to minimize the installation force on y-lateral fittings to prevent "wishboning."

5.0 Fusion Preparation

5.1 Inspection

Inspect the fusion area and the outside surface of the pipe for unacceptable damage (cuts, deep scratches, gouges, etc.). Do not use damaged fittings or pipe.

5.2 End Preparation

Ensure that the free end of the pipe does not have any necking or toe-in. The machined fusion ends of the fabricated fitting should be free of any deformation, and should conform to ASTM D 2513 dimensions.

5.3 Cleaning

Use only clean, dry and lint-free non-synthetic cloths for cleaning fusion surfaces, and areas where fusion equipment will be secured. Isopropyl alcohol may be used to clean fusion surfaces. Do not touch or otherwise contaminate fusion surfaces after cleaning.

5.4 Equipment

Ensure that all fusion equipment is properly calibrated and in suitable working order. Ensure equipment has adequate fuel prior to initiating the fusion process.

Use a pyrometer or IR thermometer to double check the temperature of the heater several times throughout the day.

Use only collets, clamps and equipment designed for the size of pipe, and for the type of fusion performed. Do not use excessive force to clamp pipe or fittings.

5.5 Cold-weather Fusion

Fusion in cold weather may affect the fusion parameters. Be sure to check and test the fusion process in cold weather to guard against unsatisfactory joints.

Ensure the fusion area and equipment is sheltered from wind, as well as precipitation and other sources of moisture. Scrape off any accumulated snow or ice from the fusion area before starting fusion.

Cold temperature can affect the dimensional and mechanical properties of polyethylene. Slight OD contraction is possible, although typically compensated for by fusion equipment. Polyethylene may have increased stiffness and less resistance to impact, so increased caution when handling in cold weather conditions is advised.

5.6 Trial Fusion

Perform trial fusions at least once per day per size of fusion to requalify the fusion procedure and parameters (See 7.0). Multiple trial fusions may be required throughout the day if weather conditions are changing.

6.0 Fusion Procedure

Throughout this section, the terms ‘force’ and ‘pressure’ may be used interchangeably to describe the force between the pipe ends, the facing tool and the heater. This does not refer to the hydraulic pressure of the fusion machine. Be sure to follow the guidelines of the fusion machine to calculate the appropriate hydraulic pressures required to attain the fusion forces / fusion interfacial pressures as described here.

6.1 Initial Parameters and Start-Points

The following values provide a suitable starting point for setting fusion parameters. These shall be adjusted until a suitable fused joint can be reliably attained via qualifying fusion.

Heater Temperature: 210±10 °C [410±18 °F]
 Interfacial Pressure: 60 – 90 psi [415 kPa – 620 kPa]
 Drag Pressure: Variable - set per fusion
 Cooling time: 30 – 90 sec /in pipe diameter

Regardless of fusion parameters, the cycle is split roughly into two parts, heating and cooling.

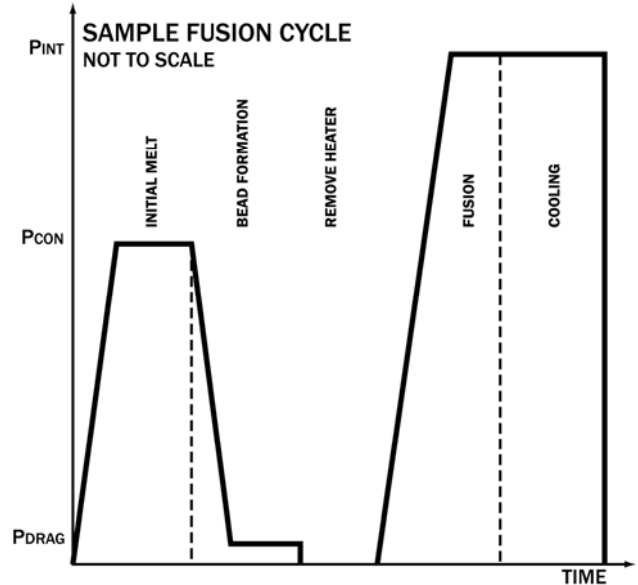

Figure 6.1 The Fusion Cycle

In Figure 6.1, the heating portion includes the initial melt, and the bead formation areas. Cooling begins immediately after the heater is removed, the pipe ends are joined.

The interfacial pressure is used to determine the required force, F_{FUSION} , between the pipe and fitting to ensure a successful fusion.

$$F_{FUSION} = P_{INT} \cdot A_{PIPE} = P_{INT} \cdot \pi \cdot OD^2 \left(\frac{SDR - 1}{SDR^2} \right) \text{ [lbf]}$$

Where: P_{INT} = Interfacial Pressure [psi]
 OD = Actual Pipe OD [in]
 SDR = pipe standard dimension ratio
 π = 3.1415

If the cylinder area, A_{CYL} , of the fusion equipment is known, the hydraulic pressure required (P_{HYD}) can be found via the following:

$$P_{HYD} = \frac{F_{FUSION}}{A_{CYL}} + P_{DRAG} \text{ [psi]}$$

Do not omit the drag pressure, P_{DRAG} when calculating the required hydraulic pressure. Drag pressures for longer length of pipe, or pipe made less flexible in cold weather can be on the order of several hundred psi. Measure the drag pressure for every fusion joint by noting the minimum required hydraulic system pressure to move the fusion machine carriage.

6.2 Procedure

6.2.1 Secure, Face and Align

Starting with clean pipe and fittings (see 5.3), place the fusion ends of the pipe and fitting into the clamps of the fusion machine.

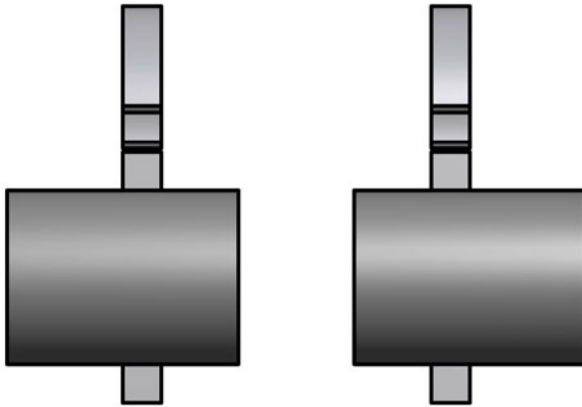

Figure 6.2.1.1 Place pipe ends in open fusion machine clamps

Do not force components into the open clamps of the machine.

Ensure there is enough material exposed from the fitting and pipe ends to allow enough material for fusion following facing.

Secure Clamps, and bring ends together to check alignment. Tighten clamps, if required, to round high pipe. Do not loosen clamps to round low pipe. The pipes

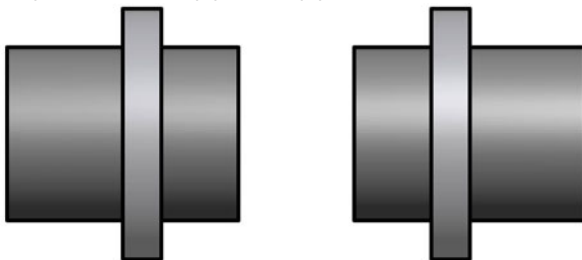

Figure 6.2.1.2 Secure pipe by closing fusion machine clamps

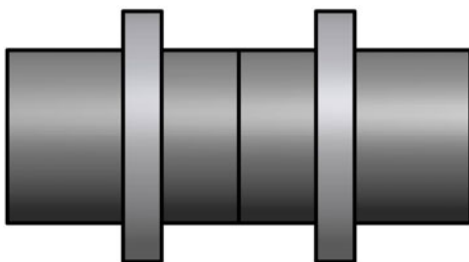

Figure 6.2.1.3 Checking alignment of pipe ends. Adjust as required.

Insert the facing tool between the pipe ends and apply reasonable pressure to the facing tool to ensure parallel and smooth mating surfaces.

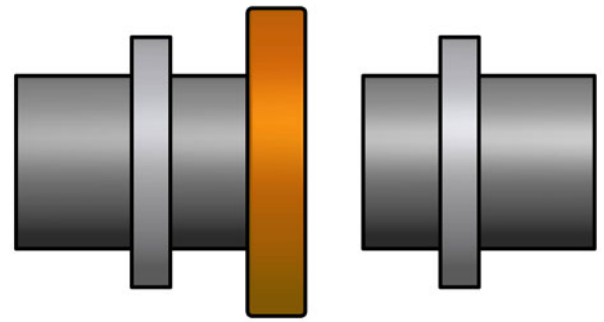

Figure 6.2.1.4 Insert Facing tool between pipe ends

Facing is complete when continuous ribbons of material are removed from each turn of the facing tool. If fusion equipment is equipped with facing stops, remove material to the stops.

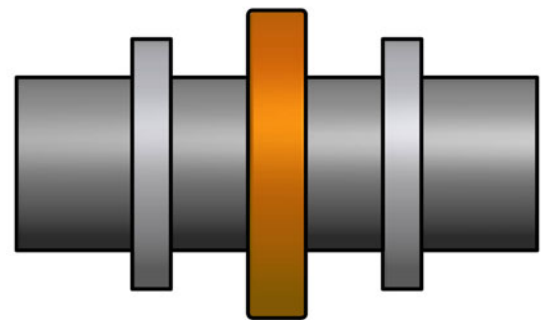

Figure 6.2.1.5 Remove material with facing tool

Remove the facing tool, remove any shavings and debris and bring the pipe ends together to confirm alignment.

Do not touch surfaces with bare hands after facing. This will contaminate the fusion.

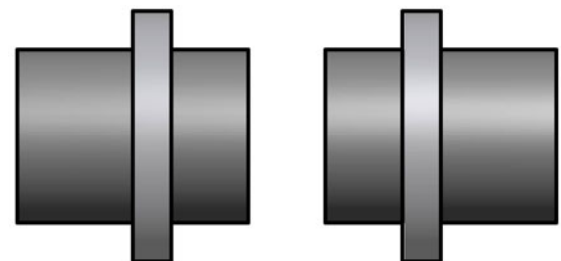

Figure 6.2.1.5 Remove facing tool

Bring the ends together to confirm alignment. There should be no gaps between the pipe ends, and the ends shall be concentric and round. If adjustments to alignment are required (clamp tightening, repositioning, etc.), reface the ends and reconfirm alignment afterwards.

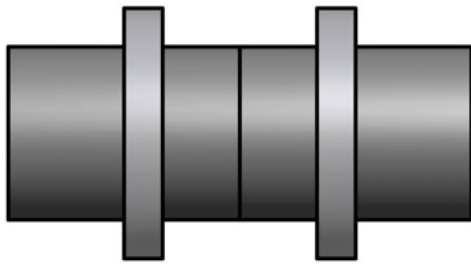

Figure 6.2.1.6 Reconfirm pipe alignment

6.2.2 Melt and Bead Formation

Fusion must only be performed at the specified fusion temperature. Ensure the heater element is at temperature before introducing it into the fusion process.

Insert heater between the pipe ends, and bring the pipe ends together with the contact pressure.

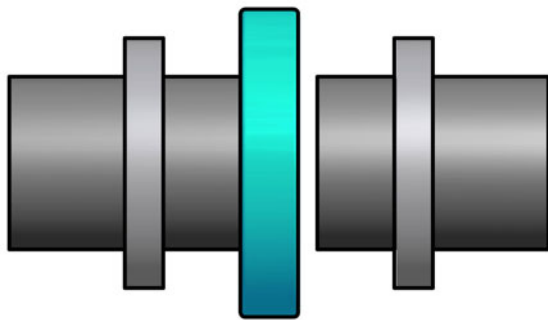

Figure 6.2.2.1 Insert Heater between pipe ends

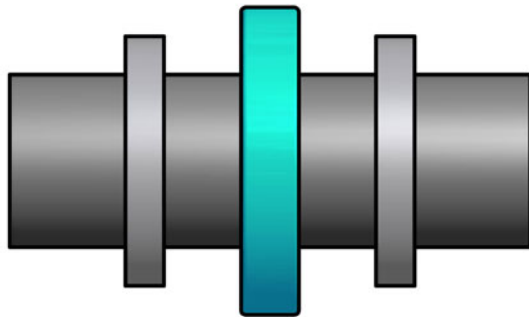

Figure 6.2.2.2 Apply Contact Pressure

Hold the pipe ends against the heater at contact pressure until there is indication of melt around the circumference of the pipe ends.

Lower the pressure between the pipe ends and the heater to drag pressure, per fusion machine manufacturer specifications. Do not separate the pipe ends from the heater. If the pipe ends lose contact with the heater, cancel the fusion procedure, wait for pieces to cool, and start again from 6.2.1.

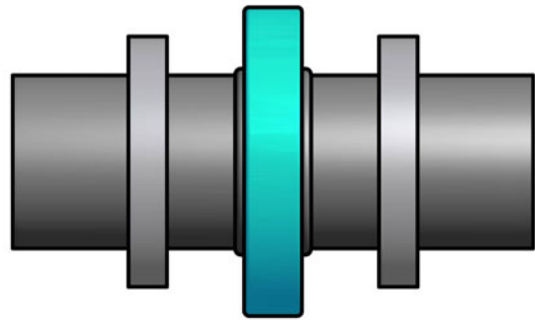

Figure 6.2.2.3 Reduce pressure when melt around pipe is evident.

Keep the pipe ends in contact with the heater at the drag pressure until the appropriate-sized bead forms. Consult table 6.1 for bead size ranges.

Pipe Size (NPS)		Bead Size H (mm)	
From	To	From	To
2	3	2.0	3.0
3	8	3.0	5.0
8	12	5.0	6.0
12	24	6.0	11.0

Table 6.2 Recommended Bead Sizes for Pipe Size Ranges

Refer to figure 6.2.6.1 for dimensional diagram

6.2.3 Remove Heater & QUICKLY inspect

Once the bead on the pipe ends is the appropriate size, bring the pipe ends apart and remove the heater. Quickly inspect the ends for indications of failure. The melted surfaces should be smooth, free of bubbles or marks, and flat.

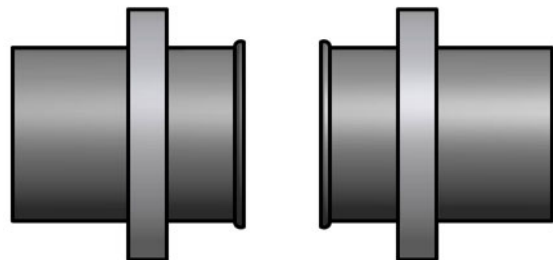

Figure 6.2.2.4 Remove heater and inspect fusion surfaces.

6.2.4 Join

If the pipe ends are acceptable as per 6.2.3, quickly, but gently, bring the pipe ends together and ramp up to joining pressure.

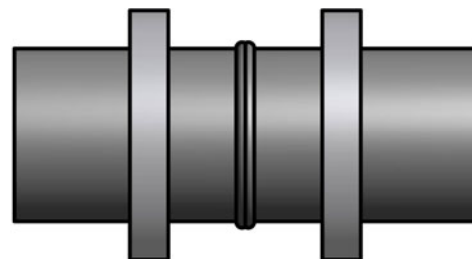

Figure 6.2.2.3 Bring ends together with fusion force.

If there is a discrepancy in the appearance of the joint as the pipe ends are fused (misalignment, debris, bubbling or any

other rejection criteria) allow the joint to cool, cut apart, and restart fusion procedure from 6.2.1.

6.2.5 Hold

Hold the pipe ends together until the fusion joint is cool to the touch. Thicker wall pipe will take longer to cool than thinner wall pipe.

When the joint is cool to the touch, the fitting and pipe can be subjected to GENTLE handling. The joint should be allowed to cool for a further 30 to 45 minutes before further installation, pressure testing or any other action that will impart stress to the joint.

6.2.6 Inspect

The bead should be symmetrical and uniform around the OD and ID of the pipe and fitting. Refer to figure 6.2.6.1 for successful fusion bead size and shape proportions.

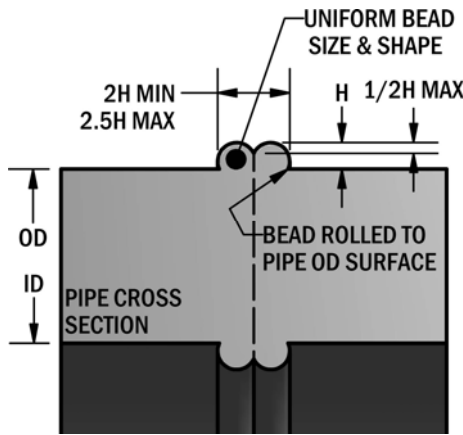

Figure 6.2.6.1 Cross section of fusion joint with proper bead

6.3 Troubleshooting

Based on inspection of the bead, the following table lists some possible causes of fusion failures.

Observation	Possible Cause													
	Equipment - Clamp Slip	Equipment - Worn	Facing - Incomplete	Heat - Excessive Temperature	Heat - Excessive Time	Heat - Insufficient Temperature	Heat - Insufficient Time	Heater - Defective	Joining Force - Excessive	Joining Force - Insufficient	LHC Contamination	Materials - Dissimilar	Misalignment	Soak Pressure - Excessive
Excessive Double Bead Width														
Double bead groove too deep														
Flat Bead														
Bead not uniform around pipe														
Bead larger than other														
Beads too small														
Beads not fully rolled (shallow 'V')														
Beads not fully rolled (deep 'V')														
Beads too Large														
Speckled or divotted bead														

Table 6.3 Bead symptoms and possible causes.

7.0 Quality Control and Assurance

7.1 Qualifying Fusion Procedure

To qualify a fusion procedure, a sample joint must be prepared and tested per ASTM D 2657 (or ERCB Directive 077 if fusion PE 80 or PE 100 pipe).

7.1.1 Sample Joint

Prepare a sample joint. The each fusion end must be at least 15 wall thicknesses long, with a minimum length of 6 in.

7.1.2 Fusion

Follow the procedure outlined in 6.0 to obtain a sample fusion. It is advised that the qualifying fusion process be observed to ensure procedures are followed. Inspect the completed joint against a known reference photo or sample to confirm it is an acceptable joint.

7.1.3 Cool

The sample joint should be allowed to cool for no less that 60 minutes before continuing the test procedure.

7.1.4 Test Strips

Cut, at minimum, three test strips from the sample joint. The dimensions of the test strips are provided in figure 7.1.

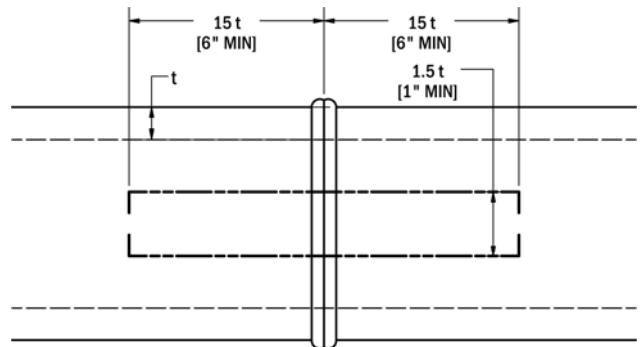

Figure 7.1 Sample Strip dimensions (ASTM D 2657)

7.1.5 Examine and Bend Strips

Examine the weld cross section area for any voids or contamination. An acceptable weld is monolithic, and there should be no unbonded areas.

7.1.6 Repeat as Necessary

If the joint is unacceptable, repeat the process making adjustments to parameters (as suggested in 6.3) to achieve a successful fusion joint.

Qualifying fusions should be performed during changing weather conditions and for each size of fusion performed.